

## Lotus-30

### 5.3W Single Round 48VDC LED Nano-Track Luminaire

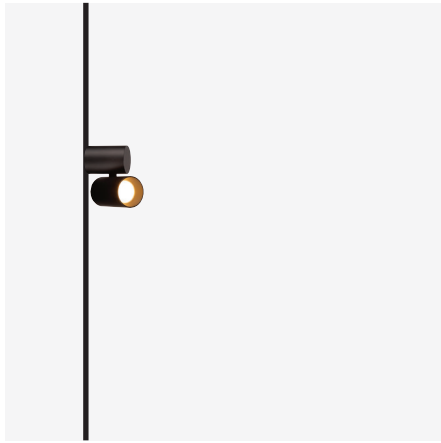

Luminaire Finishes

Black (BK)     White (WH)

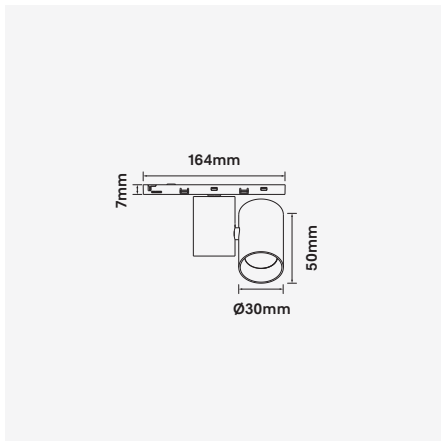

WATTAGE 5.3W
15° / 24° / 36° / 50°
VOLTAGE 48VDC
CRI (Ra) >90
CE
WARRANTY 5YR

3-Step
IP 20
Track
355° 30°

48VDC low voltage track lighting is synonymous with electrical safety, providing greater flexibility in design and ease of use including installation. The Nano-Track, with its minimal foot print makes it a perfect solution where light is required and space is limited. The luminaire can be installed and moved to any position without the need for turning off power to the track.

The luminaires snap-lock into position, remaining in place until you want to remove or re-position the luminaire. The simplistic and compact design makes this a versatile solution for a variety of spaces and applications. Available with a multitude of accessories to create a range of designs, the Lotus-30 comes with a 5 year warranty.

- Luminaire wattage: 5.3W (System)
- Luminous flux: 460Lm<sup>2</sup>
- Luminaire efficacy: 87.35Lm/W<sup>1</sup>
- Correlated colour temperature: 2700K, 3000K, 4000K
- Colour rendering index: >90<sup>3</sup>
- 3-Step-MacAdams Ellipse
- LED Brand: Bridgelux COB series
- Optical distribution: 15°, 24°, 36°, 50°
- Luminaire Ø30mm x Depth 50mm
- Adjustability: ±30° Tilt; 355° Rotation
- Luminaire finishes: Black, White
- Ingress protection rating: IP20
- Working voltage: 48VDC constant voltage
- Flicker free DC-DC internal driver
- Longevity: >50,000Hrs L80 B10
- Driver: Integral DC-DC Flicker-Free non-dimmable
- Requires: 48VDC constant voltage LED driver, Nano-Track system
- Weight: 95g (excluding driver)
- Warranty: 5 year<sup>4</sup>

Model	LED Output <sup>2</sup>	Luminous Flux <sup>2</sup>	System Wattage	CCT	CRI <sup>3</sup>	Distribution
LOTUS-30-5.3W-3K	623Lm	460Lm	5.3W	3000K	>90	15°, 24°, 36°, 50°

For Non-dimming add suffix ND

Example product order code configuration: LOTUS-30-5.3W-3K-24-ND-(BK)

Model	Wattage	CCT	Distribution	Driver	Luminaire Finish
LOTUS-30	5.3W	3K	24	ND	BK

#### Light Distribution

Lotus-30-5.3W-3K-40

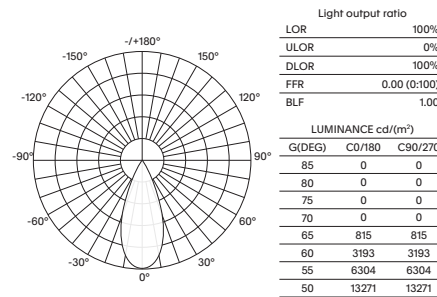

AVERAGE BEAM ANGLE (50%): 41.7 DEG

Room Reflectance	Utilisation Factors									
	Room Index									
Ceiling   Walls   Floor	0.80	1.00	1.25	1.50	2.00	2.50	3.00	4.00	5.00	
70   50   20	91	95	99	102	105	106	108	110	112	

#### Cone Diagram

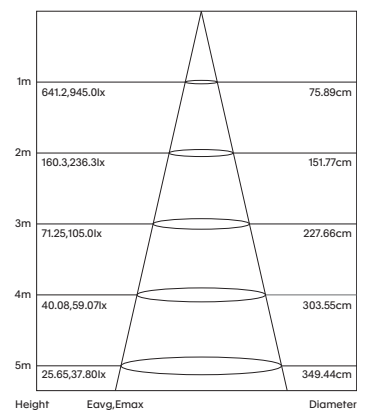

## Lotus-30

### 5.3W Single Round 48VDC LED Nano-Track Luminaire

#### 48VDC Nano-Track options

Surface Track  
Product No: NTR-SM19  
Colour: Black, White  
Size: W19mm x H10mm

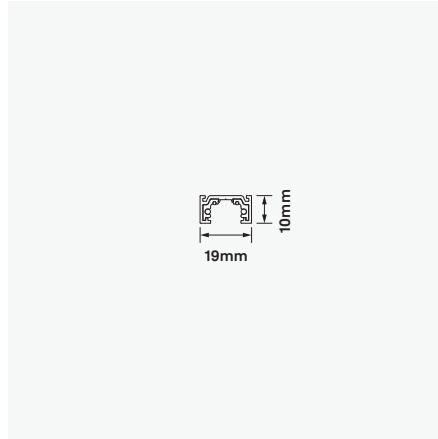

Trimless Track  
Product No: NTR-TL19  
Colour: Black, White  
Size: W40mm x H11mm

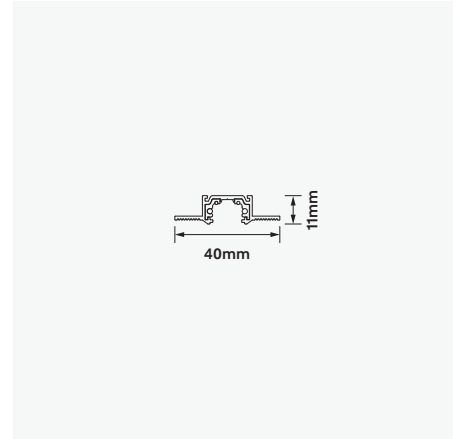

Suspended Track  
Product No: NTR-SUS22  
Colour: Black, White  
Size: W22mm x H18mm

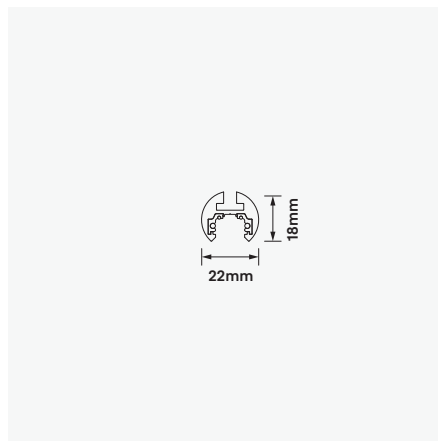

- 1 Luminaire efficacy based on CCT 3000K; CCT variation will alter efficacy
- 2 +/- 10% stated initial LED and luminous flux tolerance
- 3 Colour Rendering Index: >90 Standard (Bridgelux COB series)
- 4 Five year manufacturer's warranty covering product defects and performance deficiencies